

2025

SKILLS Project 'A' BRM
Post secondary



Stefano Liessi

SKILLS Post Secondary

1/1/2025

CCUSECA24001 / Skills

Body Repair Manual (BRM)

DISCLAIMER: THIS MANUAL HAS BEEN SPECIFICALLY CREATED FOR THE SOLE INTENDED PURPOSE OF THIS PROJECT, IN NO WAY SHAPE OR FORM SHOULD IT BE USED WITH REPAIRS TO AN ACTUAL VEHICLE

READ ALL OF THE INSTRUCTIONS PRIOR TO COMMENCING

Sectioning procedure / rocker panel

You will be provided three components. One component will be a fully assembled rocker panel section. The next two components will be an inner backing panel and a formed outer panel. These two pieces are your repair pieces. The assembled component will be referred to as 'THE VEHICLE' the two separate pieces will be referred to as the 'SALVAGE' pieces. (inner and outer)

Rocker assembly

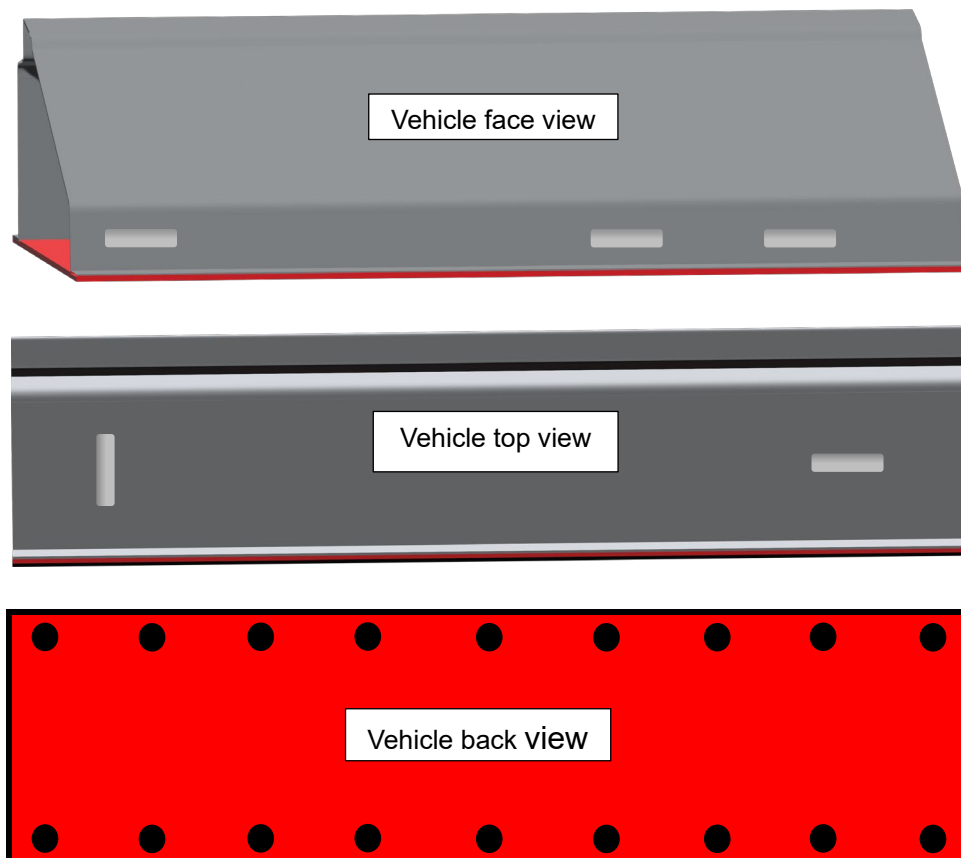

Salvage pieces

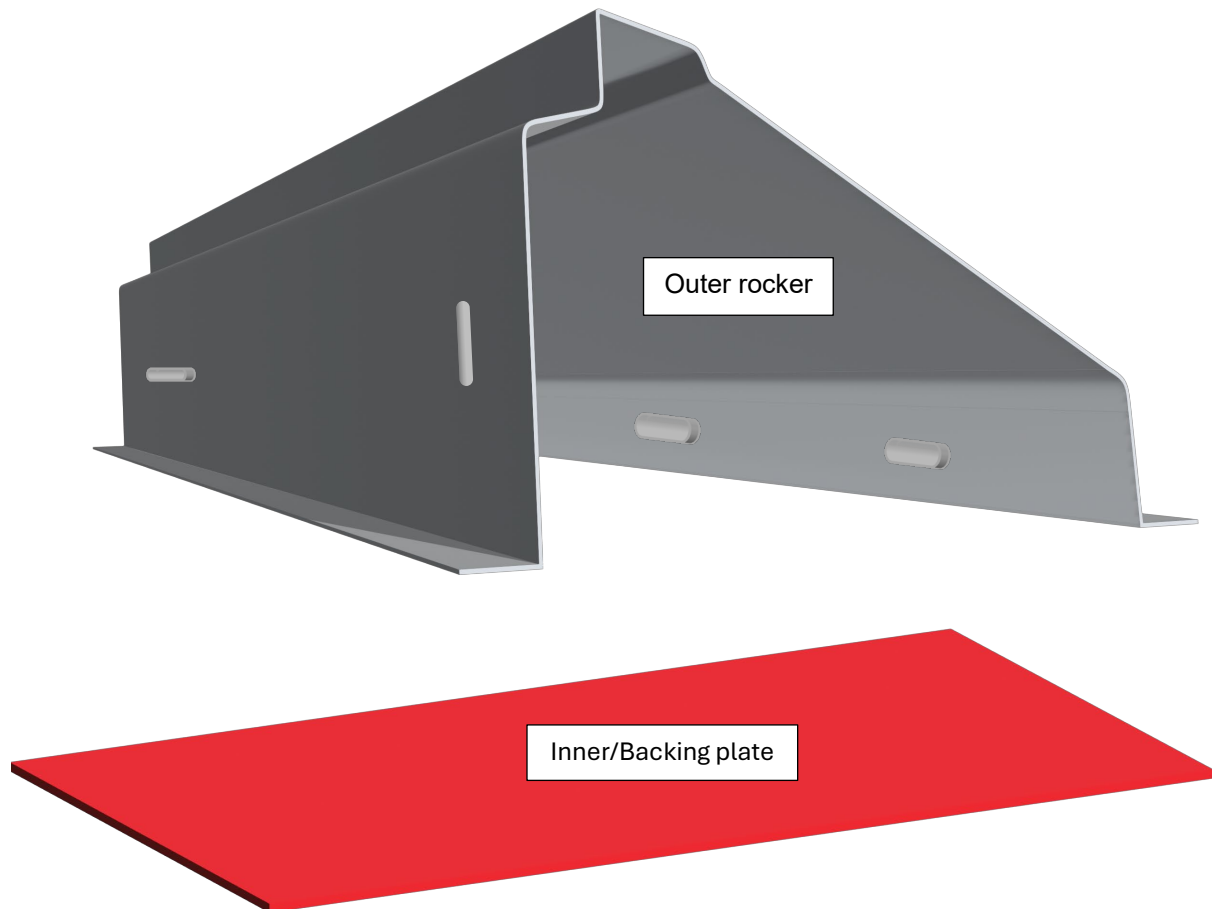

Legend:

SKILLS Alberta Sec. Post Sec.

Rocker section

Satin coated mild steel

22g outer panel

16g backing panel



***** OEM procedure notes*****

Per this OEM, all plug welds used to secure 1.0mm (22g) or less, must be done using a 6.5mm hole. All plug welds securing components made of 1.5mm(20g) or greater must be done using a 8mm hole. Plug welds should be placed back in OEM position, do not add or subtract any welds. All corrosion protection must be replaced prior to welding. Welder set up and test welds must be performed based on materials and stacking being joined as per OEM procedures. This applies to ALL welds, plug, open butt, butt with backing. Check for continuous fusion, penetration, and voids. Follow welder guide to set up.

Tips for success

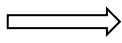
1. Measure the overall length of the vehicle component, record your findings.
2. All measurements are in millimeters (mm)
3. Mark each component for consistency using an arrow for direction 
4. Make all measurement marks using a scratch awl, DO NOT USE A SHARPIE
5. As you complete each step, highlight it, scratch it out, add a check mark, however you chose, mark each step complete so you are not second guessing your work.
6. Write notes for reference in the BRM, do not try to 'remember' important items
7. In the BRM, highlight your measurements and the location they are taken from.
8. Measure twice cut once, mark out your cut lines and double check with the BRM
9. When marking out the cut lines be sure to mark on the piece which side of the line to cut on. (you can use tape or mark directly on the piece)
10. Always cut short of the line, then dress the excess up to the line.
11. Once parts are trimmed, test fit for precise measurements, once verified, THEN trim for root gap.
12. Remember to allow for root gaps and maintain your root gaps as you complete the project.
13. The use of run-on run-off tabs are strongly recommended
14. Space out your welding to maintain heat control, spread out your plug welds, and space out your seam welds by doing them in sections. You can also cool with air.
15. Clean out the weld through primer from areas of direct arc for welding.
16. You may tack-weld components and recheck fit and measurements.
17. Welds must have continuous fusion, no holes, skips, or misses.
18. When dressing a weld, be cautious not to create 'blueing' as this is detrimental to the metal causing heat damage and weakening.
19. Project must remain in the vice for the duration of the exercise.



20. PAY ATTENTION TO THE CALL THE JUDGE TO PROCEED

Legend of Operations

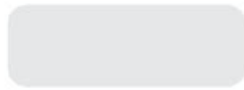

Factory Holes



Factory Spot Welds

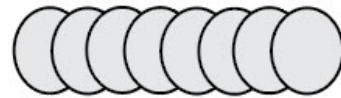

Seam Weld



Remove - Discard



Replacement Plug Welds



Dressing / Grinding

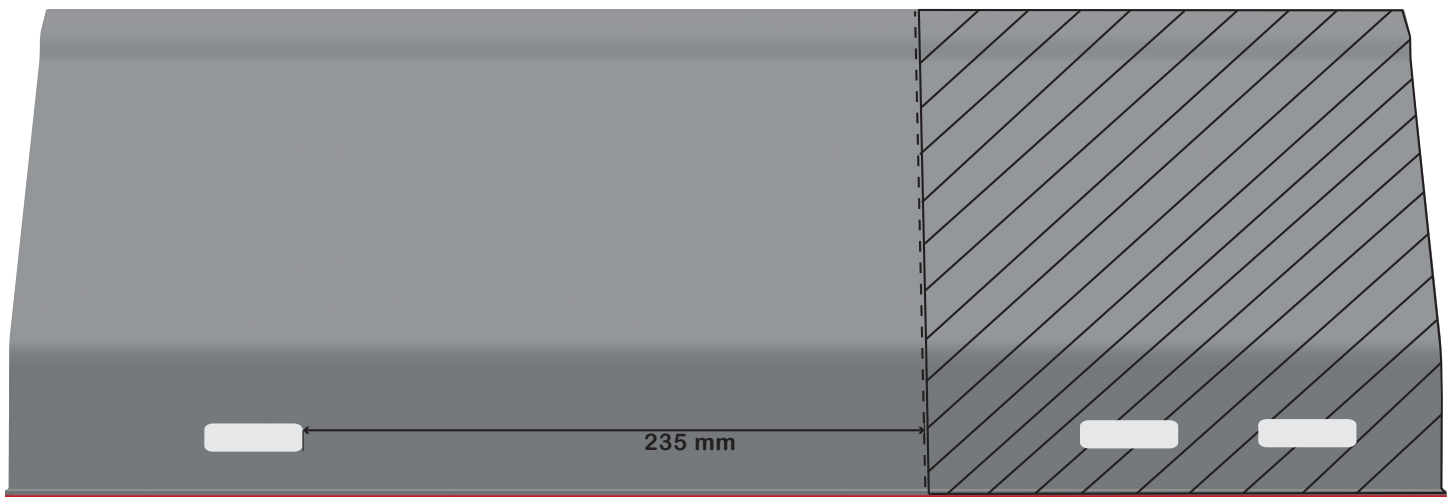

1. Clean and degrease your vehicle component and you salvage pieces.
2. Mark the component and salvage pieces for alignment (arrows, 'front,' 'left/right') however you choose, remember to be consistent, pay attention to the location of the factory holes.
3. Noting where the measurements are taken from, scribe your lines for cutting.
4. Mark which side is 'scrap'

STOP

5. Proceed to prep component for removal by drilling or grinding the spot weld locations. Take care to NOT to cut into the inner/backing plate.
6. Cut through the outer rocker along scribed markings, discard the piece.

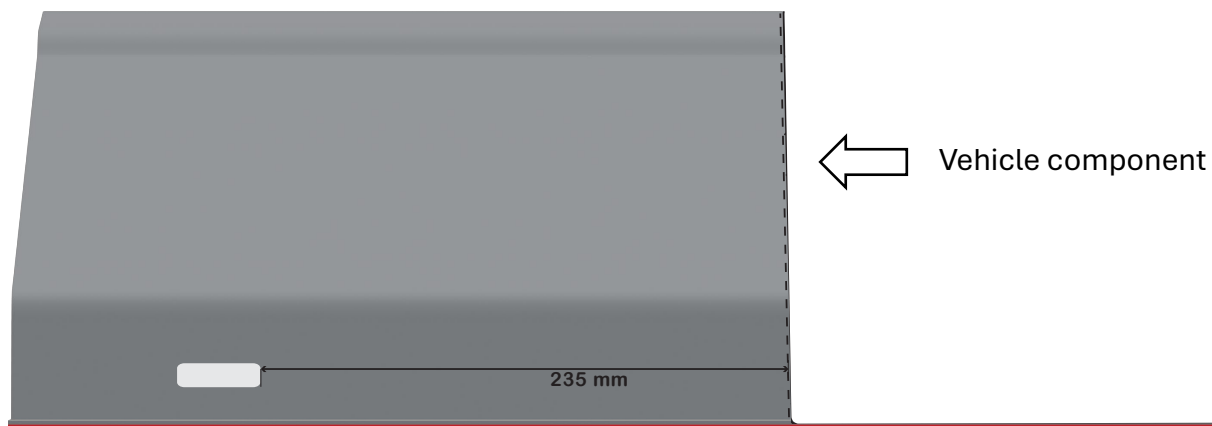







7. Clean and trim the mating surfaces to the proper given dimensions. Be sure to keep as much original material as possible.
8. On the vehicle inner backing plate mark a cut line 75mm from the end of the outer rocker vehicle component. Discard the outer piece (**save for welder set-up**)

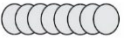

- From the salvage inner backing plate, you will cut off a 75mm section to perform an open butt joint structural weld. Remember to keep the OEM edge as your outer and use the cut edge to trim, fit, and prep for the welding process. Keep in mind the overall length and account for the root gap.



Legend of Operations		
		
Factory Holes	Factory Spot Welds	Seam Weld
		
Remove - Discard	Replacement Plug Welds	Dressing / Grinding

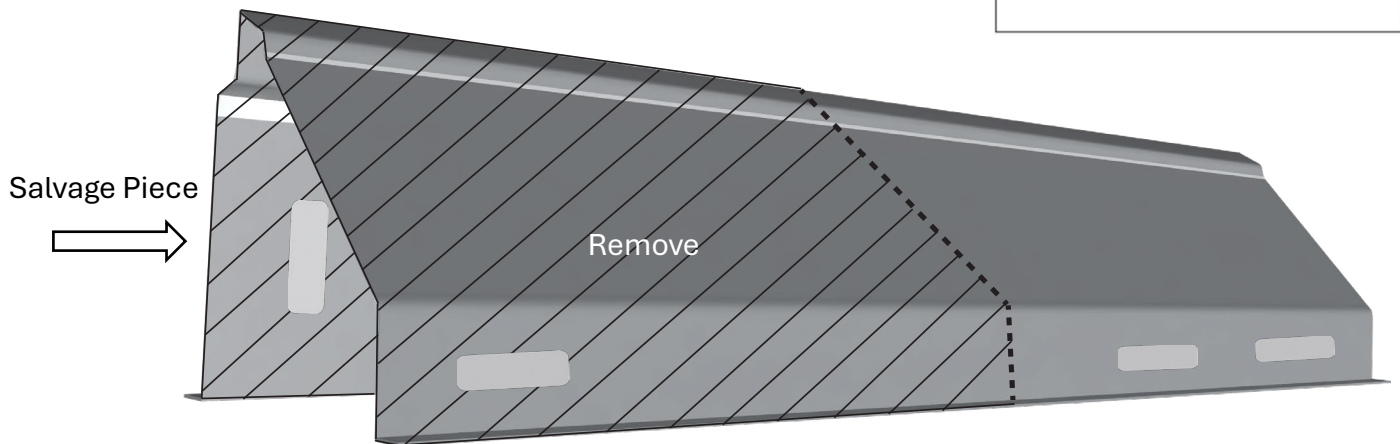

10. Based on the measurements used in the removal of the vehicle component scribe your cut lines on the Salvage Outer Rocker Panel, pay attention to what end is discarded and which end will be used. Make notes on which side to cut.
11. Cut short of the line to allow for deburring and dressing up to the line to ensure proper fitment.
12. Trim edge to ensure proper tight fitment. (root gap will be added later)
13. Mark out where the plug weld holes are to be replaced following the recommended procedures in the OEM Procedure notes.

STOP

14. Drill or punch the appropriate number of holes in the salvage piece, noting the size from the OEM procedure notes.



Salvage piece with plug holes laid out.

15. Next prepare the inner reinforcement surface to accept the salvage outer rocker, by deburring or dressing the surface and applying weld thru primer.
16. From the remaining salvage outer rocker piece, you will need to create a 50mm sleeve for the butt joint with backing weld location. **(see pg 8)**
17. Once you have cut the sleeve, remove the burs, trim off the flanges, and discard the flanges. **(see pg 8)**

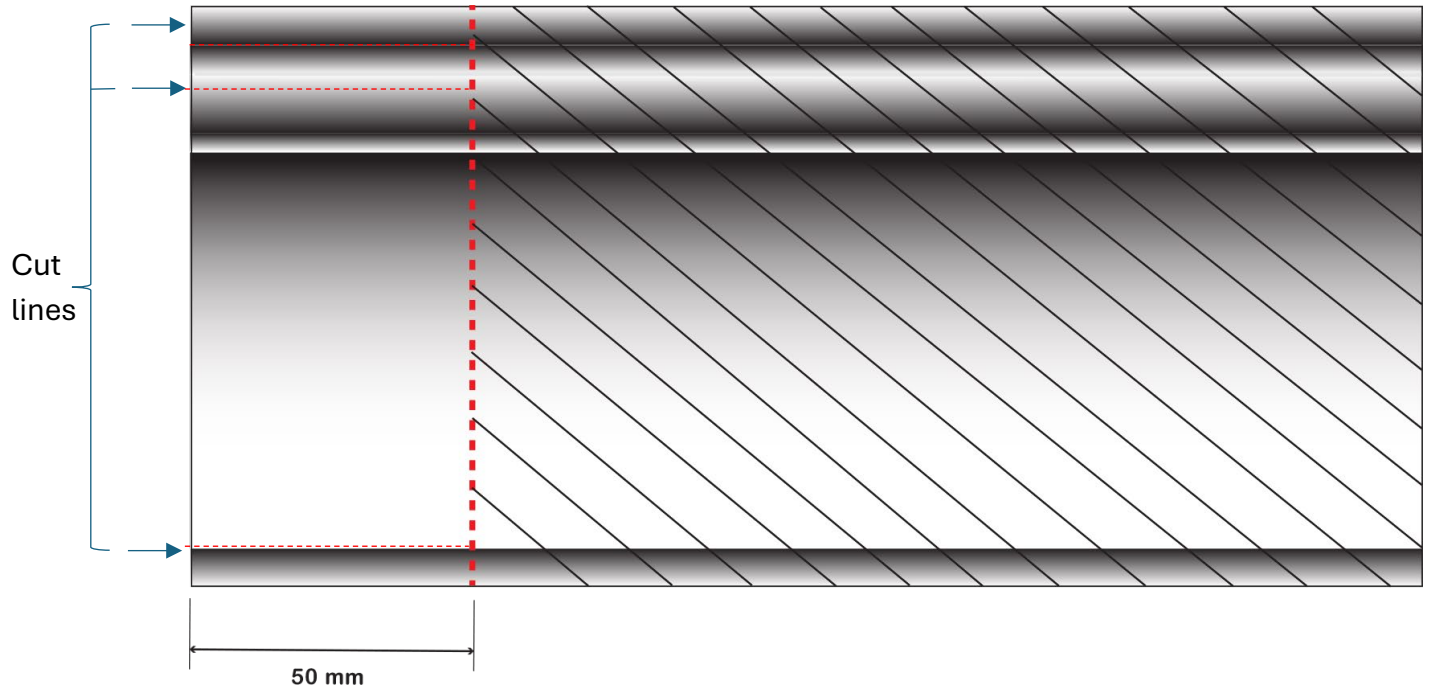

18. Next you will need to cut the sleeve in half at the appropriately marked location, this will allow the sleeve to nestle in properly behind the outer panels.

STOP

19. Once the sleeve is trimmed to fit, you will need to weld the 2 large pieces back together, this eliminates sleeve drooping during final assembly.

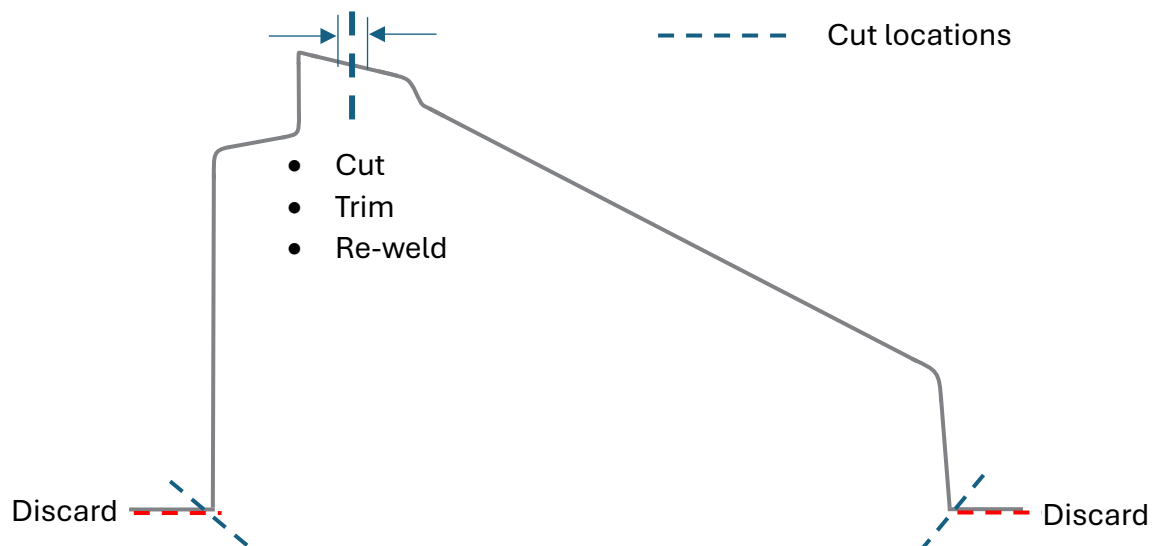

20. As per the OEM procedure notes you will add six plug weld locations to secure the sleeve into place prior to seam welding the components. Scribe and drill or punch the appropriately sized holes into the components as outlined below.

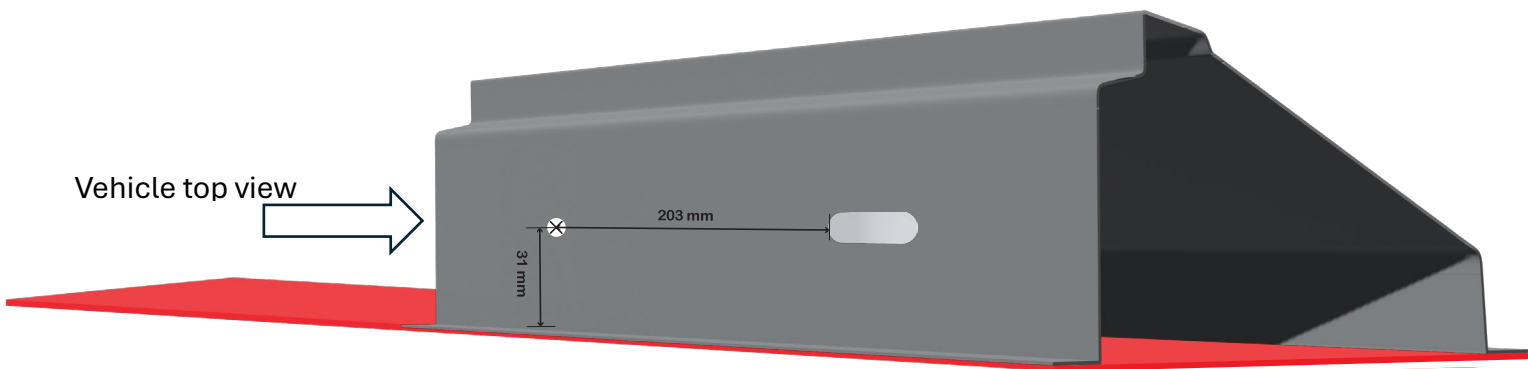
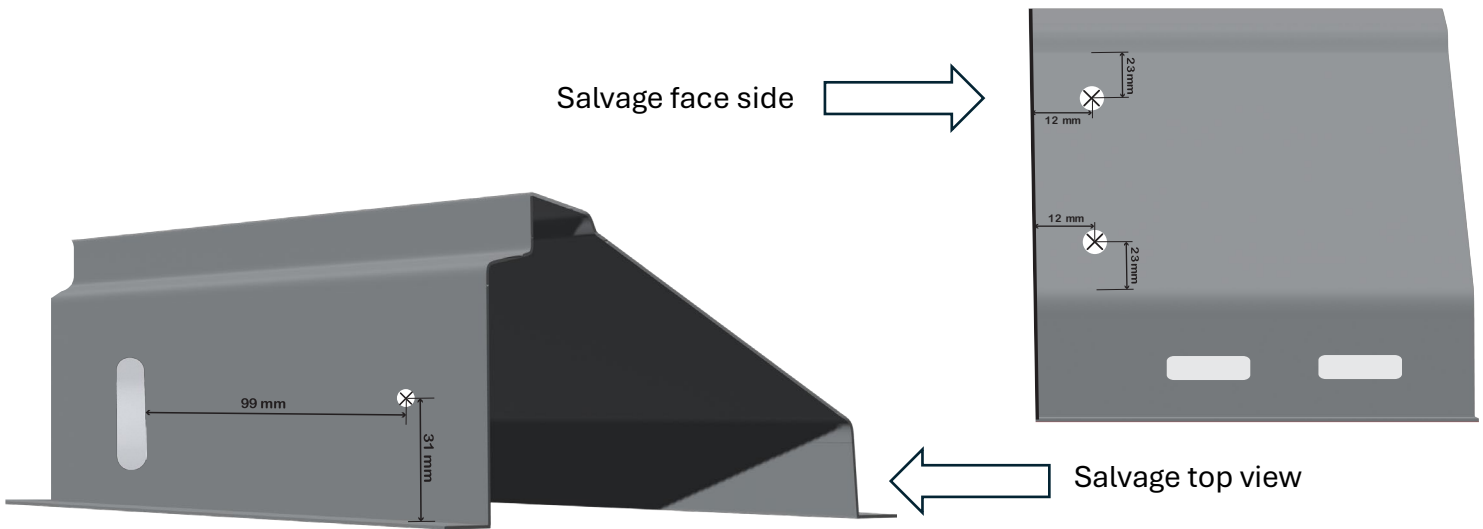
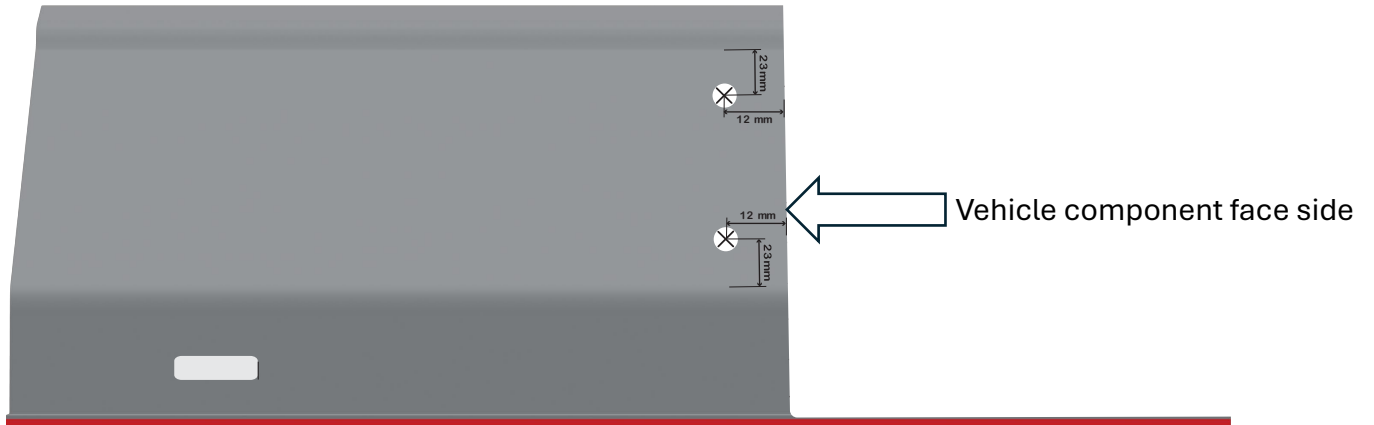

21. Fit the salvage piece into place and recheck to verify measurements. Once the overall measurements are secured, proceed to create the root gap required for the outer rocker seam weld.
22. Once the components are trimmed and satisfy the required root gap for the seam weld, prepare the sleeve and the inner backing plate to receive the corrosion protection, masking off areas that do not require it.

STOP

Welder set up

23. At this point using equal thicknesses of metal comparable to the project you will need to set your welder. Set the gas flow, the wire speed and the voltage using the chart supplied in the welder or from the electronic screen. Proceed to perform butt weld with backing samples, open butt, and plug weld samples. Perform destructive tests to verify penetration and note the weld diameter, width and height. You are looking for plug weld tear outs and tear outs from the butt with backing.

(see samples provided)

24. Adjust the root gap for the inner backer and prepare the edges to receive an open butt weld. **(bevel the edges see pg 12) (prepare run on- run off tabs)**

STOP

25. Set welder to preferred settings as per test welds and proceed to complete the open butt weld on the inner baking piece. Be mindful of the heat distribution on the panel.

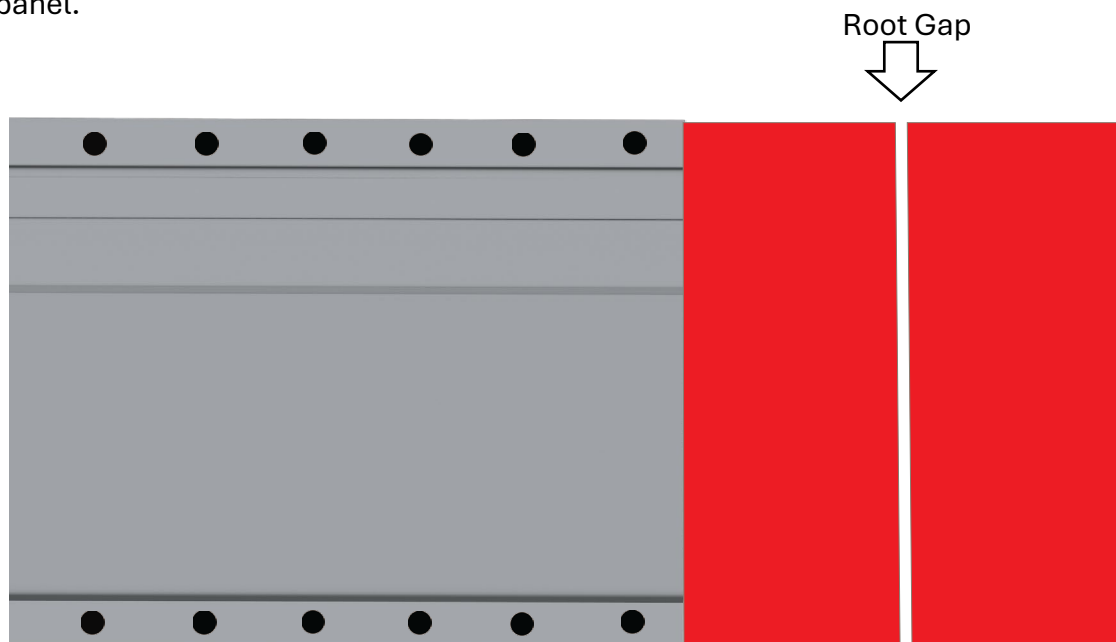

Beveled edges for root gap inner backer plate

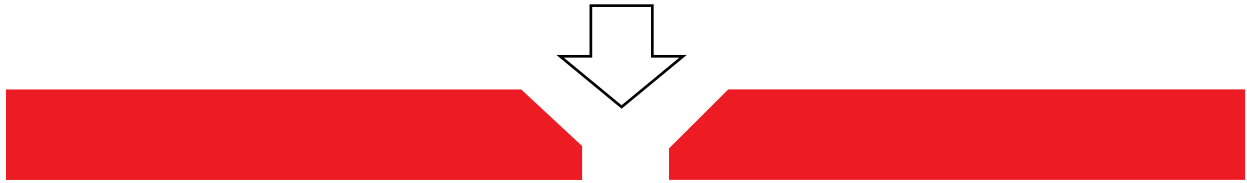

26. At this point you may secure your sleeve into either the vehicle component or the salvage piece making sure the sleeve is centered equally. Proceed to clamp the components together and weld the plug welds keeping in mind heat distribution and heat affect.

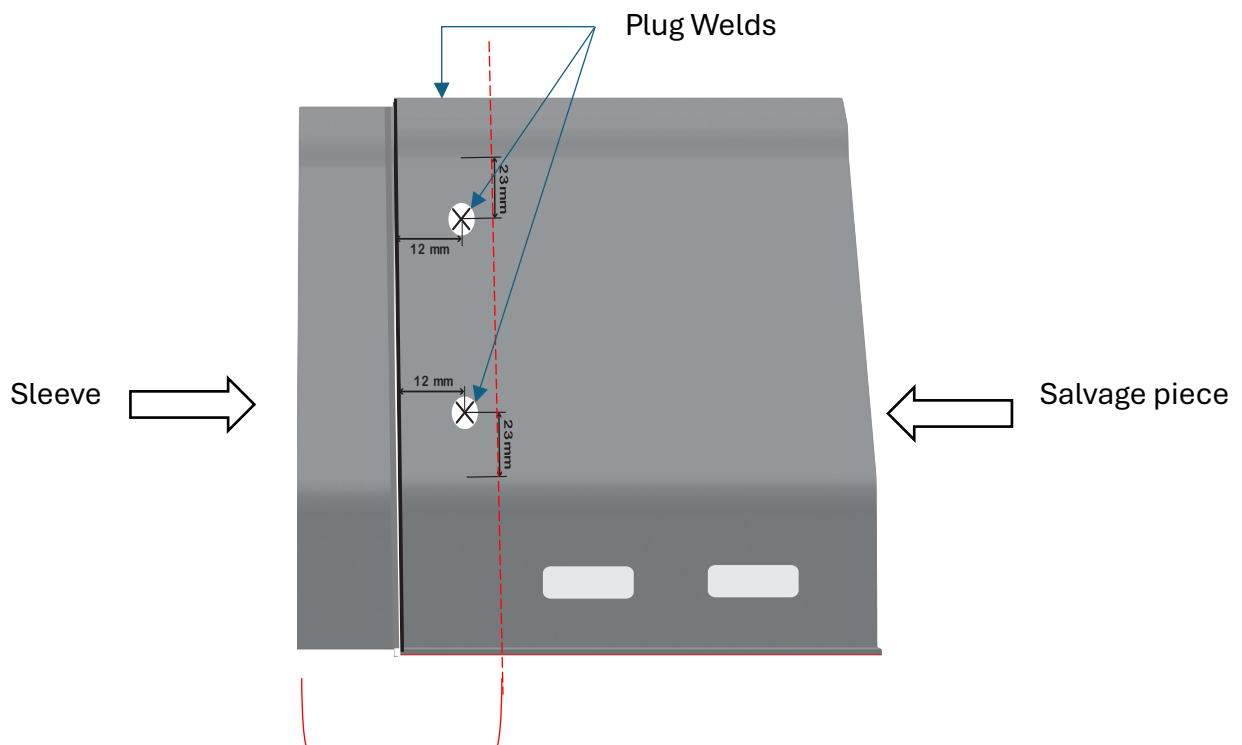

27. Combine the Vehicle component/Sleeve/Salvage pieces as an assembly and clamp together. Be sure to verify the root gap required is present, make necessary adjustments according to the OEM procedure notes and your test pieces.

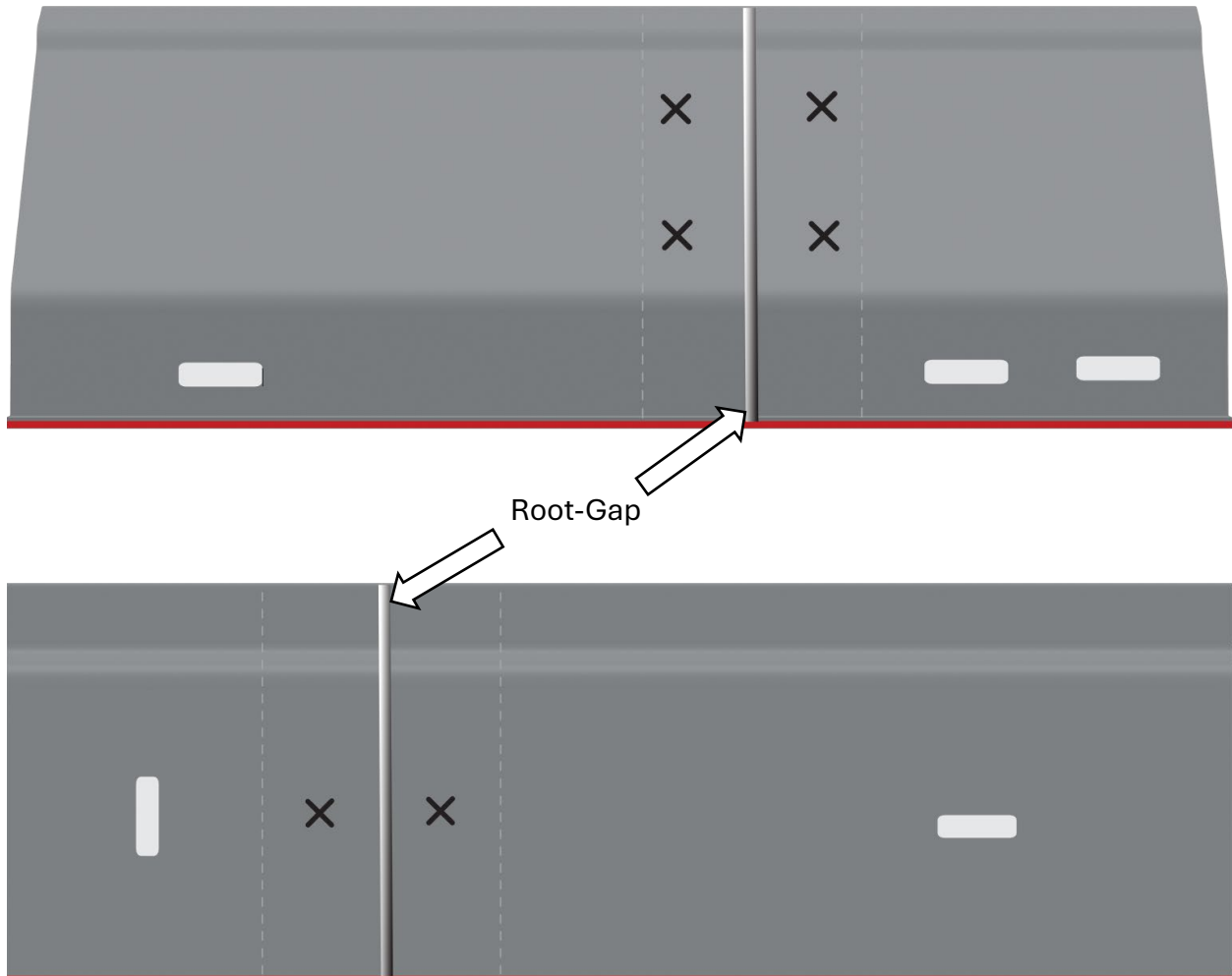
**STOP**

28. Once all the components are clamped into place and measurements are verified, proceed to place tack welds to secure the position. Once tacked into place re-measure and check root gap to verify everything is square. Continue with completing the plug welds and seam welds, keeping in mind the heat distribution by spacing out your welds. Use time and air to let the welds cool

Face side seam weld

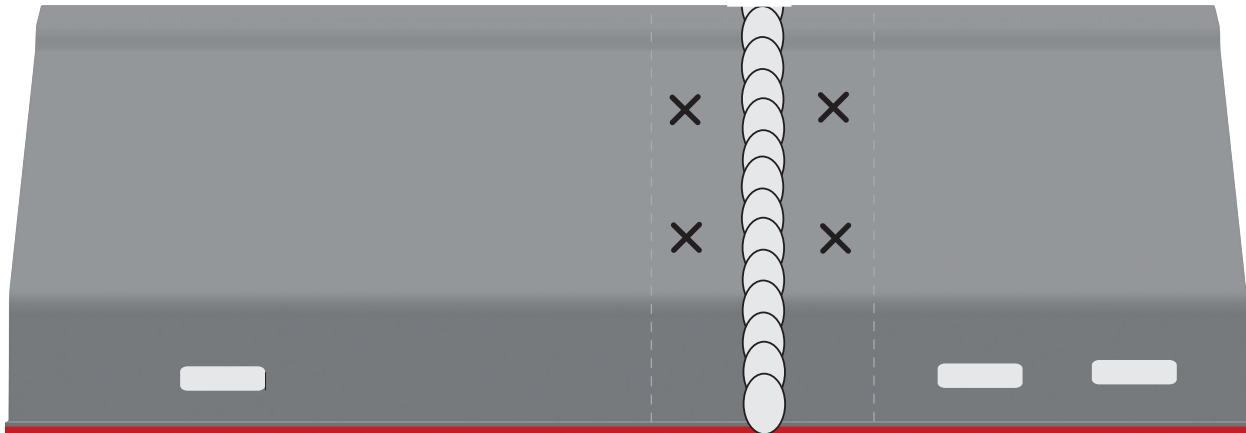

Top side seam weld

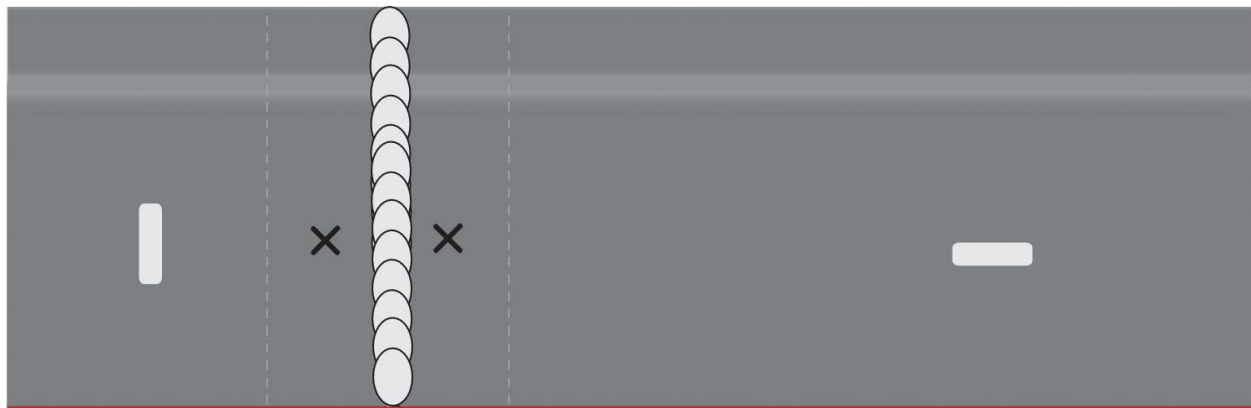

Plug weld locations

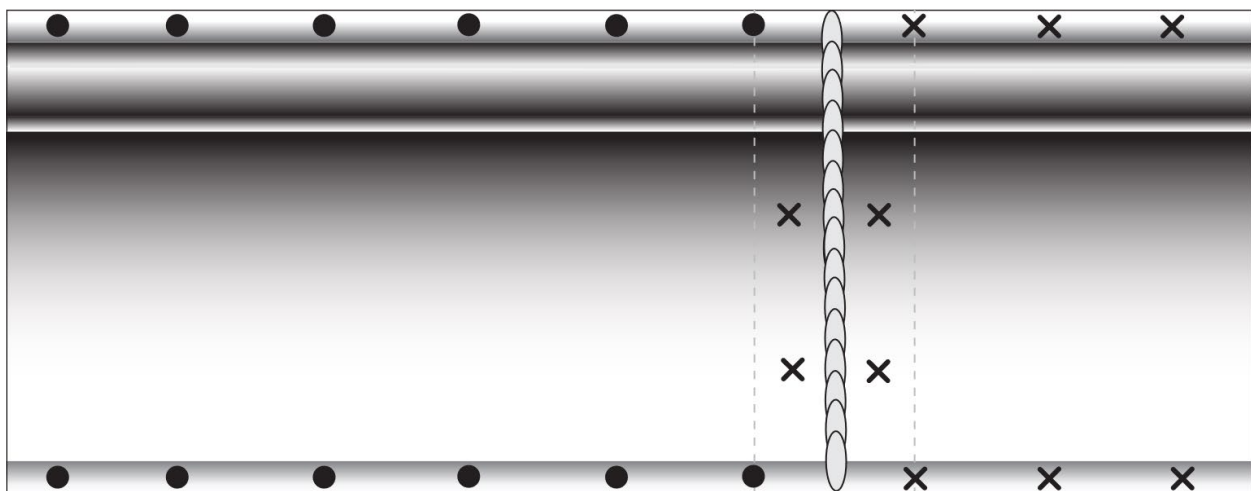

Bottom view completed Post Secondary

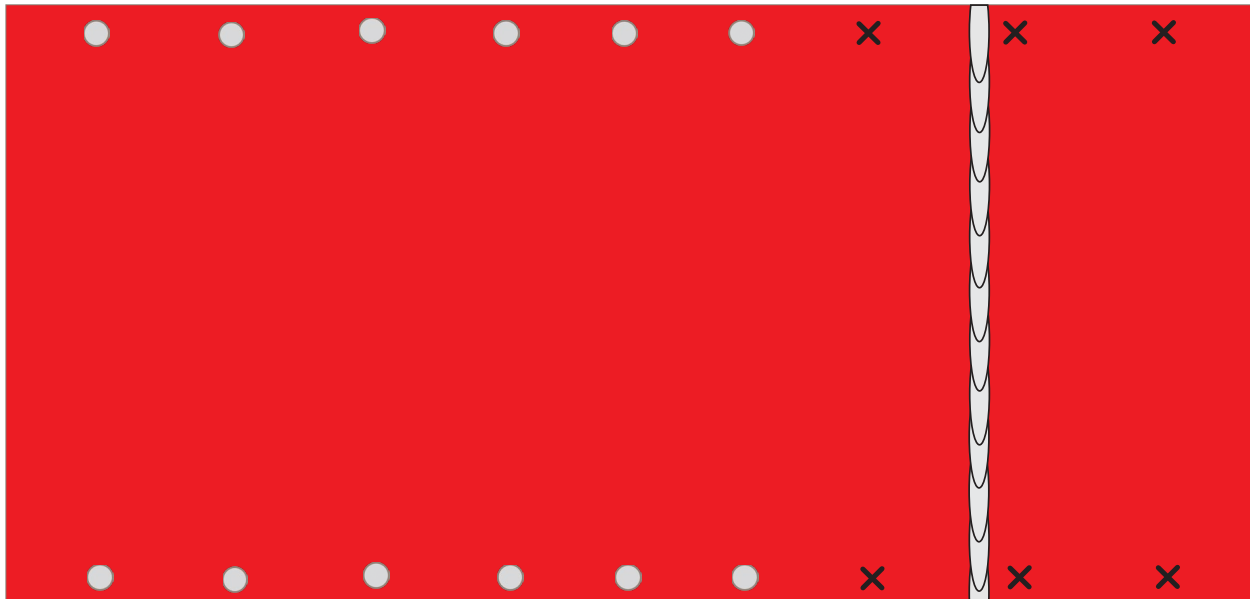
**STOP**

29. Once the welds have cooled call the judge over to determine which welds will be dressed. We are looking for 50% of the welds to be dressed. Half of your seam weld, and 5 plug welds. Take care to not 'blue' the component substrate.
30. Once the welds are dressed, remove the project from the vice, put your number on it with a sharpie, proceed to clean up your area to the condition prior to starting the project.

Congratulations you have completed an outer rocker panel sectioning

Legend of Operations

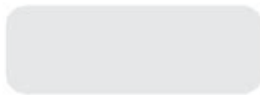

Factory Holes



Factory Spot Welds

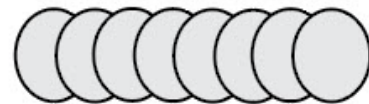

Seam Weld



Remove - Discard



Replacement Plug Welds



Dressing / Grinding